

## 2 T836/837 Installation

### 2.1 Rack Mounting

The T836 transmitter and T837 exciter are designed for use in a standard 483mm rack frame using a Tait T800 Series II guide. The guide is securely mounted to the rack frame with front and rear retaining screws, and the T836/837 is secured into the guide with two front panel mounting screws. Figure 2.1 shows a standard, double module guide which can also be fitted with an optional backplane PCB to locate and mate the rear D-range connector(s). For more information on available guide kits, refer to the T800 Ancillary Equipment Service Manual or your nearest Tait Dealer or Customer Service Organisation.

A rear mounted N-type connector is used for RF output on the T836/837, while all DC, audio and control connections are via the rear mounted D-range connector, D-range 1 (PL100). An additional rear D-range connector (T800-03-0000) can be fitted when remote multichannel operation, or additional control or low frequency lines are required (refer to Figure 2.2).

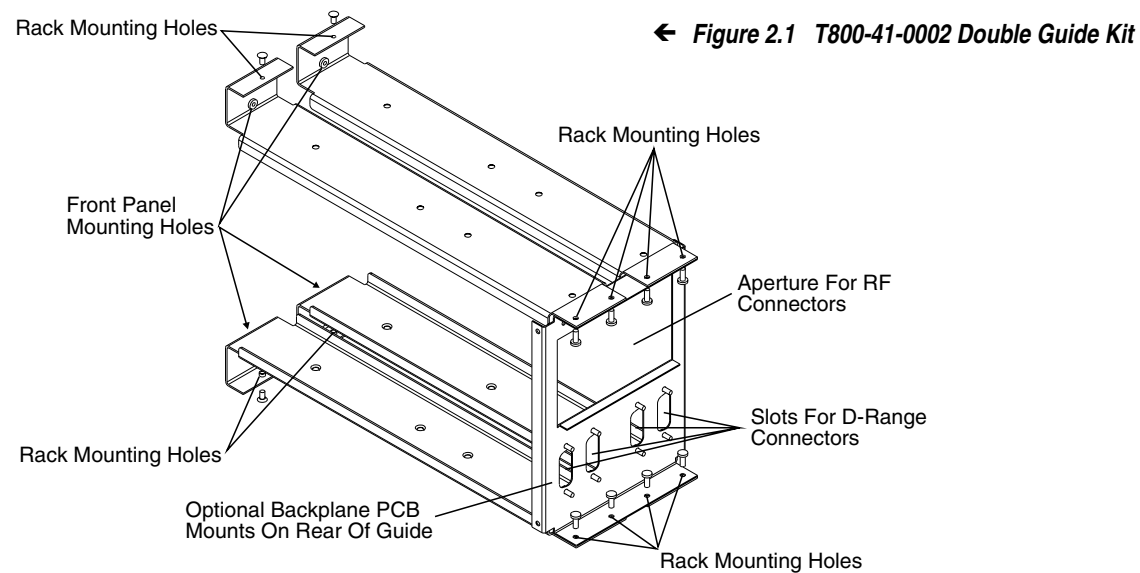

← Figure 2.1 T800-41-0002 Double Guide Kit

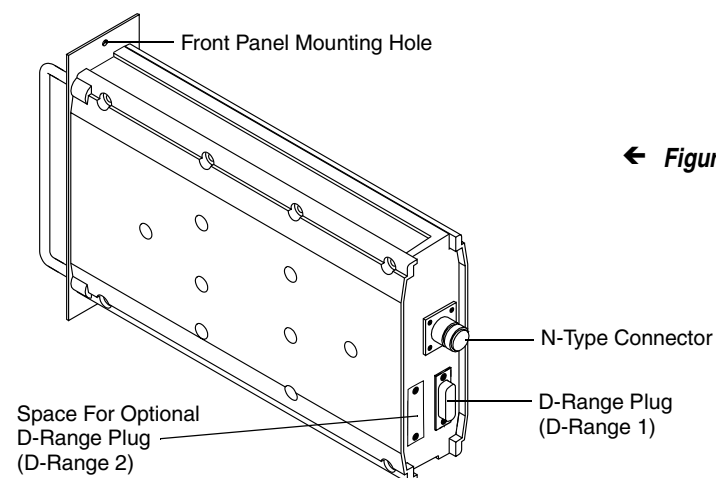

← Figure 2.2 T836/837 Chassis Connectors

### 2.2 Rack Wiring

The D-range input and output connections are shown in Figure 2.3 and Figure 2.4. Ensure that the cables are not subjected to any stresses due to tight bends or incorrect lengths.

Make sure the RF coax cable to the N-type connector is free from sharp bends or twists. If access to the rear of the rack frame is restricted, the cable should be long enough to allow the chassis to be fully withdrawn from the guide.

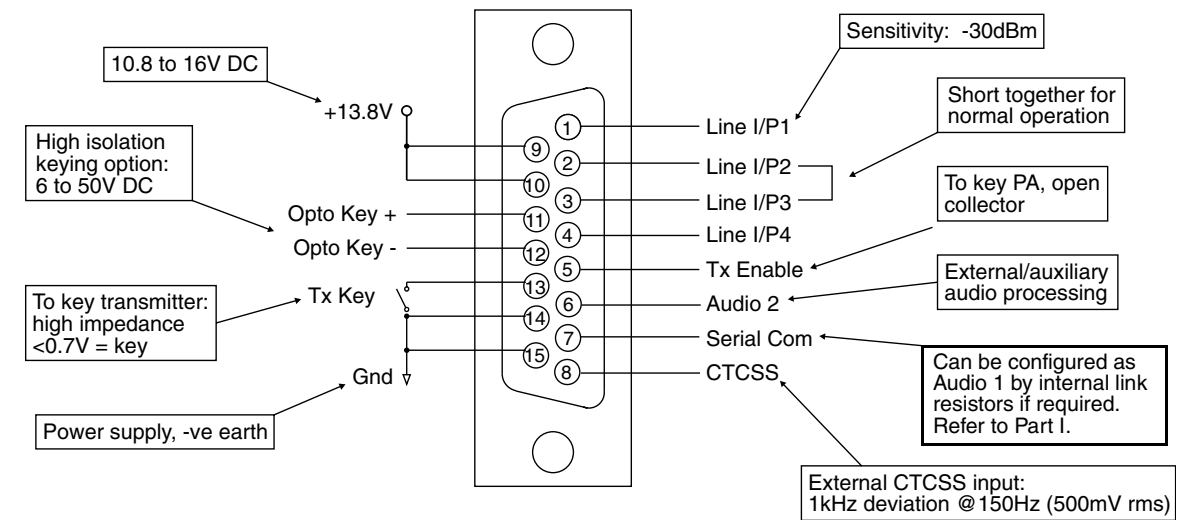

Figure 2.3 T836/837 D-Range 1 Wiring - Rear View

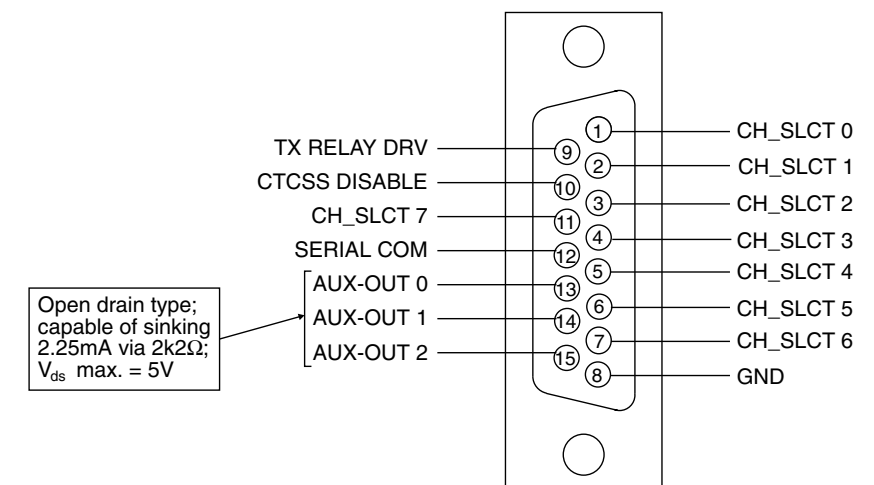

Figure 2.4 T836/837 D-Range 2 Wiring - Rear View (standard T800-03-0000 kit)

**Note:** Figure 2.4 above shows the standard pin allocations for the T800-03-0000 auxiliary D-range kit. A T800-03 auxiliary D-range kit is also available for special applications requiring custom internal wiring.

## 2.3 Power Supply

If a power supply other than an appropriate Tait model is used, ensure that it is capable of providing enough current to drive the T800 system and is also free from excessive ripple or noise.

The system should be protected by the use of appropriately rated fuses in the power supply.

**Note:** It is particularly important when the prime power source is a battery that fuses be employed in all supply lines.

## 2.4 Reverse Polarity & Overvoltage Protection

A crowbar diode is fitted to all T836 transmitters and T837 exciters for protection against connection to a power supply of incorrect polarity. It also provides overvoltage protection from voltage transients caused by lightning strikes.

**Note:** A fuse must be fitted in the power supply line for the diode to provide effective protection.